



Waste Fermentation and Sand – no Problem?

Dipl.-Biol. Kirsten Schu
EcoEnergy Gesellschaft für
Energie- und Umwelttechnik mbH
Walkenried

2nd International Symposium MBT 2007
22 – 24 May 2007, Hanover, Germany

Outline

1. Introduction
2. New Requirements for Biomass Treatment
 - Energy Efficiency
 - Waste Management
 - Emissions
3. Development of Anaerobic Digestion
4. Anaerobic Digestion of Biowaste and OFMSW
5. Mechanical Treatment
 - Pre-treatment
 - Contraries Removal
 - Dry Anaerobic Digestion
 - Wet Anaerobic Digestion
 - Wash Processes
6. Advancement of Wet Mechanical Treatment

Introduction

Anaerobic Digestion has been widely implemented over the past 20 years alongside composting. Substrates range from sewage sludge to OFMSW.

1920	Sewage Sludge
1975	Manure
1985	Organic Industrial Waste Co-Fermentate
1990	Biowaste
1995	OFMSW



Technical requirements for plant equipment increase with the proportion of „contraries“ such as glass, stones, sand and plastics:

Target:

Removal of Contraries for Protection of Equipment

Situation:

Frequent Plant Downtime in Anaerobic Digestion of OFMSW



ANALYSIS OF STATUS QUO

„Problems can never be solved by thinking the same way they were raised.“
- Albert Einstein -

New Requirements for Biomass Treatment

Energy Efficiency

- Optimizing of Total Energy Efficiency Instead of Maximum Biogas Yield
- Only the Wet, Particle Free, Anaerobic Digestible Fraction to Fermentation
- Dry Organic Fractions into Waste-to-Energy or Recycling

 **no Incineration of Manure – no Fermentation of Wood**

Waste Management

- Priority of Recycling over Energy Recovery

 **Biogas Production is no Maxim**

- Pollutants are Incorporated Into Organic Matter by Biological Treatment, Result is low Product Quality: Compost, Biomass-to-Energy, RDF, Fiber-Recycling, Plastics, Wood
- Reduction of Salt by Washing and Maximum Mechanical Dewatering Instead of Drying

 **no Biological Treatment of Utilizable Organics**

Emissions

- Avoidance of Odor Emissions for Public Acceptance
- Avoidance of CO₂-Emissions: Minimizing Energy Consumption and Unused Energy from Composting

 **Composting is not Technology of Choice**

Development of Anaerobic Digestion

1776	Discovery of Swamp Gas	1994	Demonstration Plant for Municipal Biowaste without Co-Fermentation (Bottrop)
1821	Chem. Formula methane	until 1995	Only 5 AD Plants for Biowaste in Germany
1922	Anaerobic Digestion of sewage sludge	1996	Demonstration Plants for Dry and Wet AD of OFMSW (Quarzbichl, Ravensburg, Münster)
1950	Several agricultural demonstration plants	2000	„Renewable Energy Sources Act“ (EEG)
1973	Oil Crisis, Substrates Besides Sewage Sludge	until 2004	35.000 t/a installed Digestion Capacity for OFMSW (Bassum, Kaiserslautern)
1984/ 1988	Demonstration Plants for Dry and Wet Anaerobic Digestion, mainly for Biowaste	2004	Amendment Renewable Energy Sources Act
1988	Demonstration Plants for OFMSW with low Contraries Content	2005/ 2006	Already 13 Plants with AD of OFMSW total Capacity of about 1 Million t/a
1990	„Act of Power Input from Renewable Energy“	2006/ 2007	Extensions of Commissioning, Alterations, Modifications, Down Times Shut-down of Plants, Break Downs, Discrepancies in Quality and Throughput, Company Sellings, Insolvencies

Mechanical Treatment ⇒ AD-Technologies

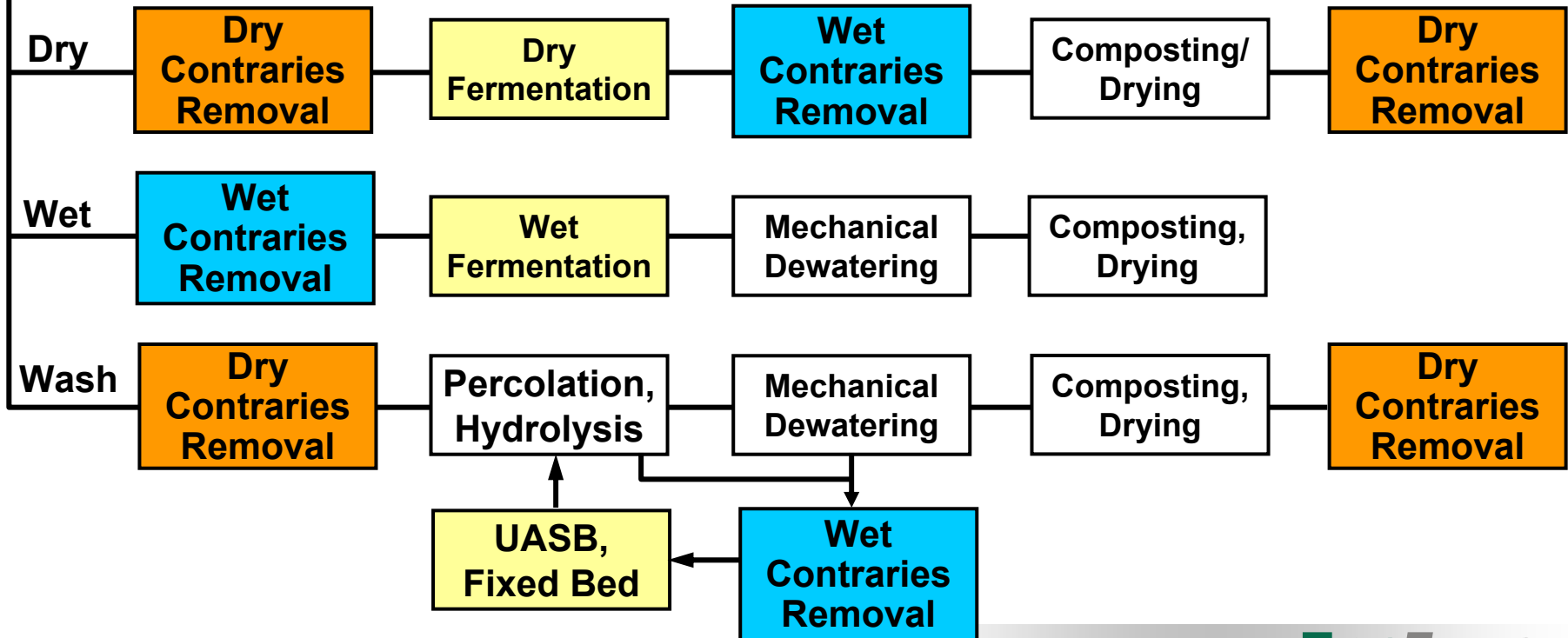
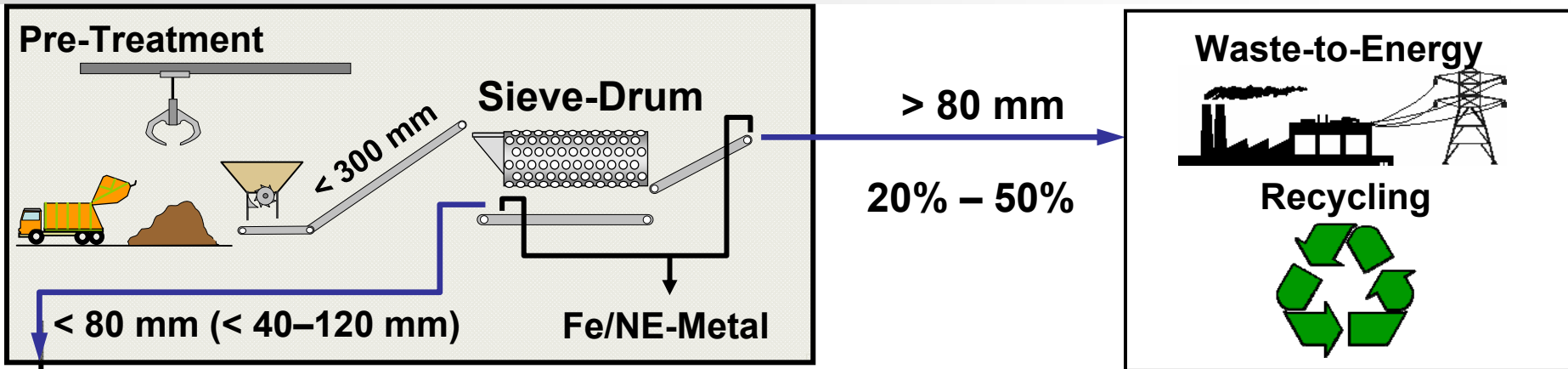

Contraries Removal for Dry Anaerobic Digestion

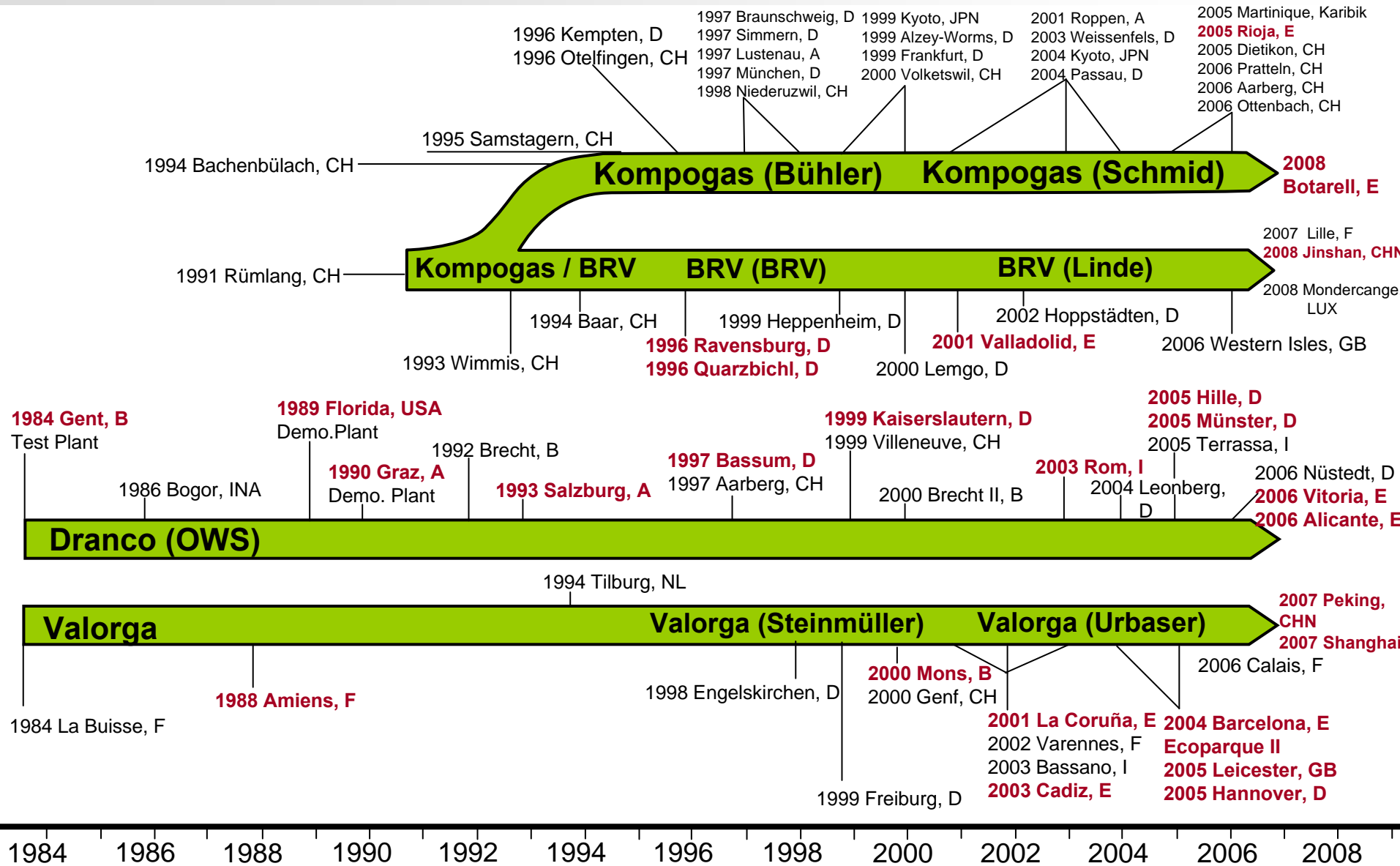

Concept Valorga-Steinmüller – Contraries Removal – Dry AD of OFMSW

100.000 t/a OFMSW

Adapted from: Company brochure BBP Steinmüller Valorga, 2001

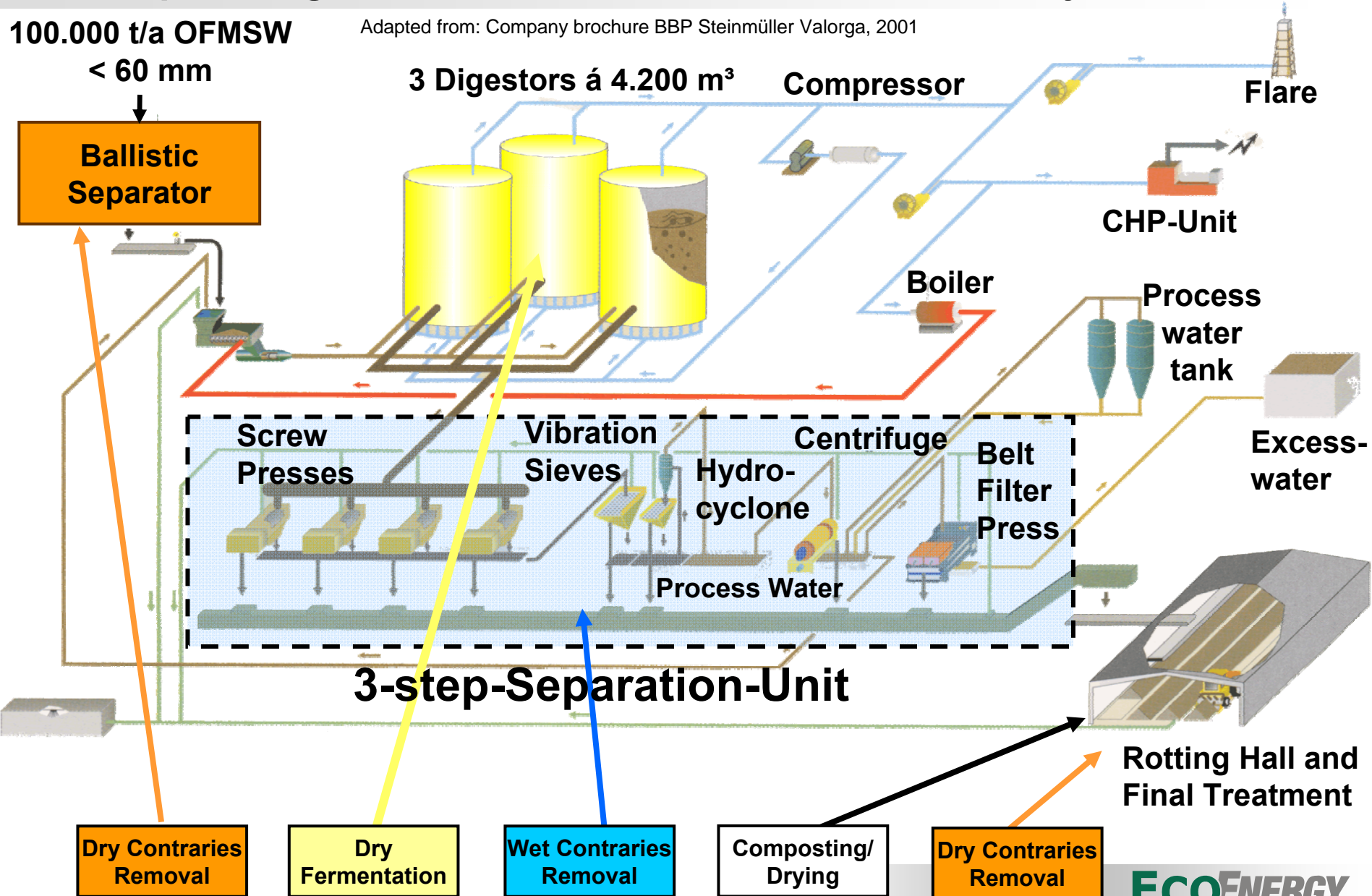

Bühler Kompogas® - Dry AD of Biowaste - Sand Removal

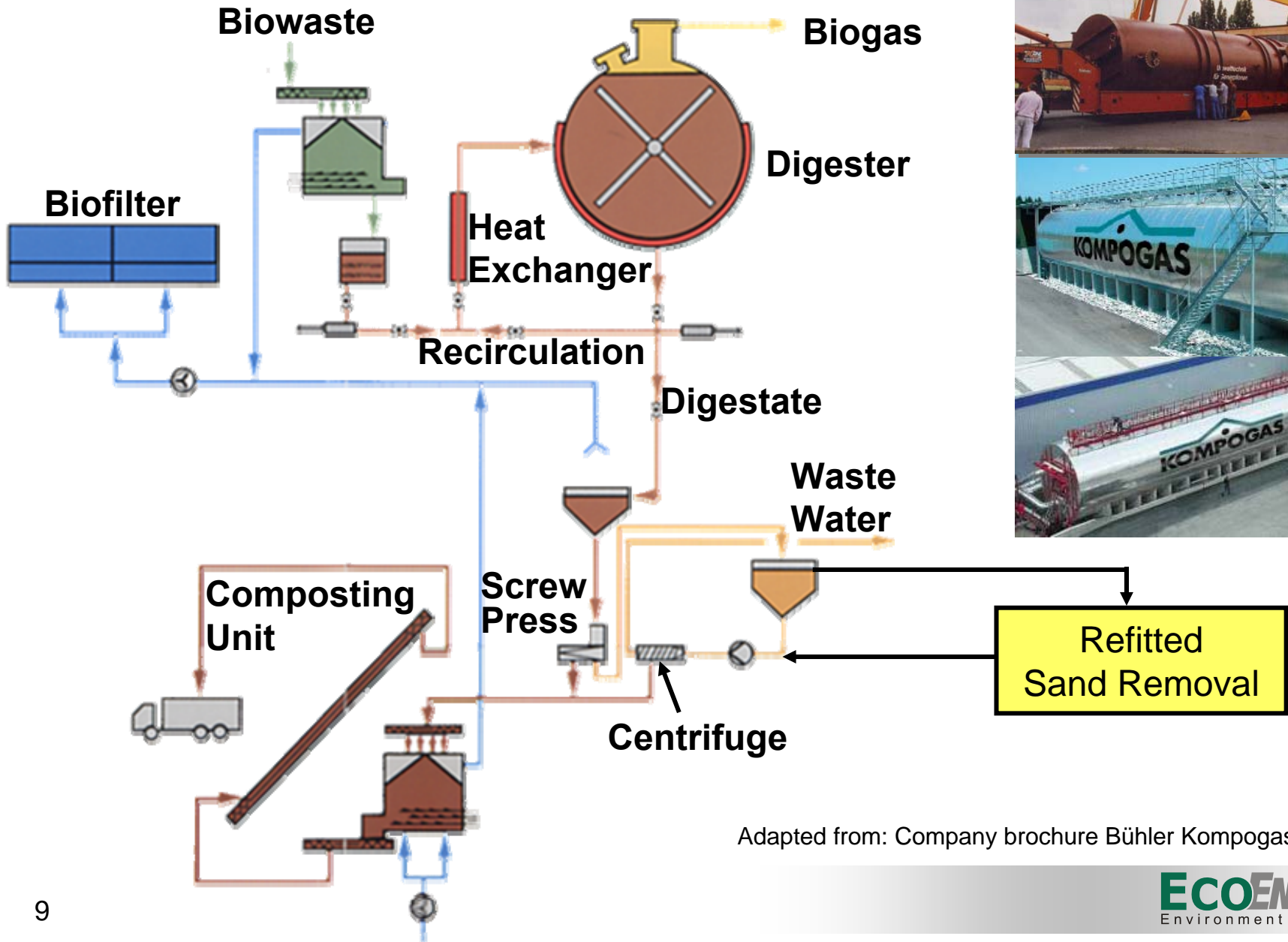

Adapted from: Company brochure Bühler Kompogas

Contraries Removal For Wet AD

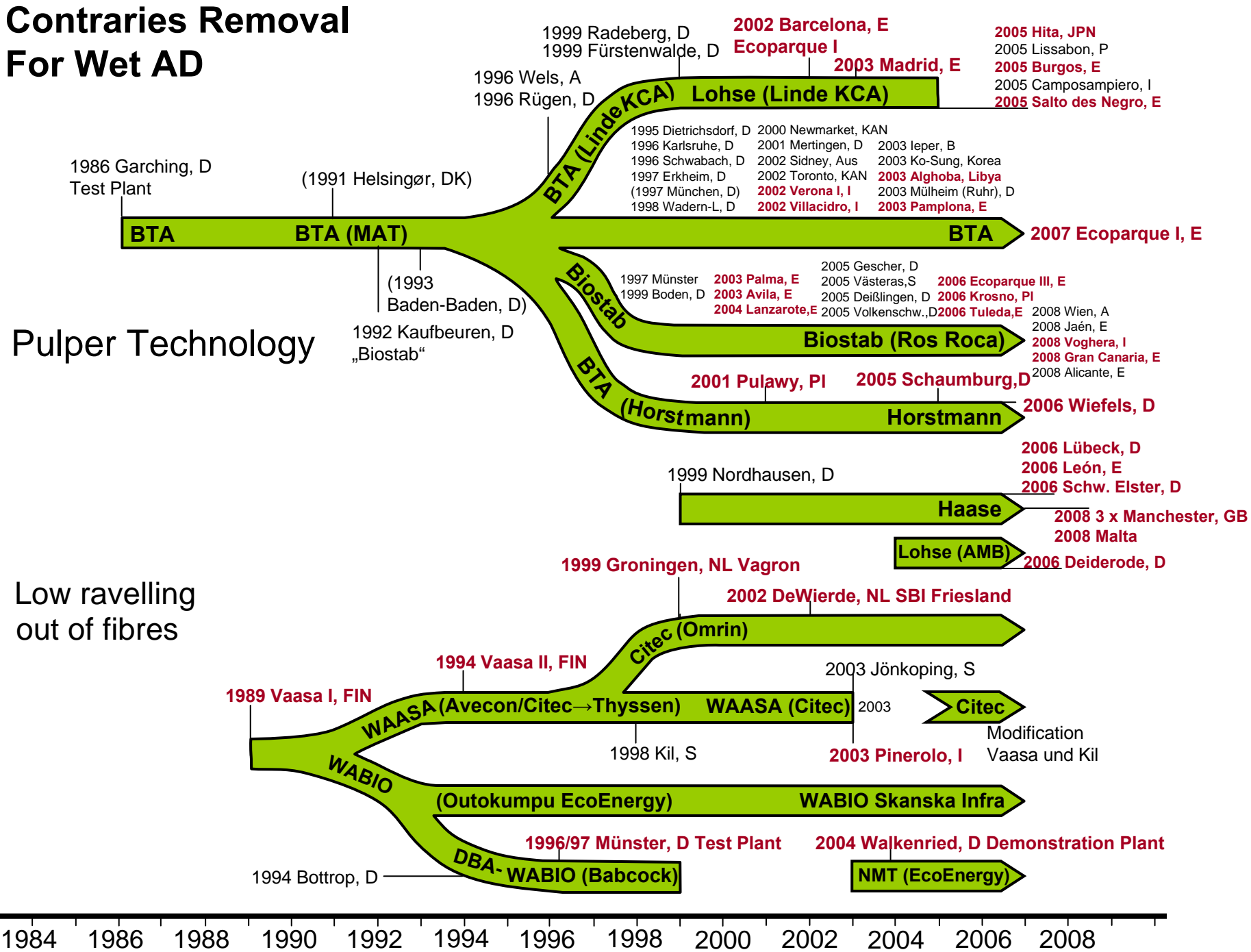

Wet Contrary Removal for Wet-Fermentation

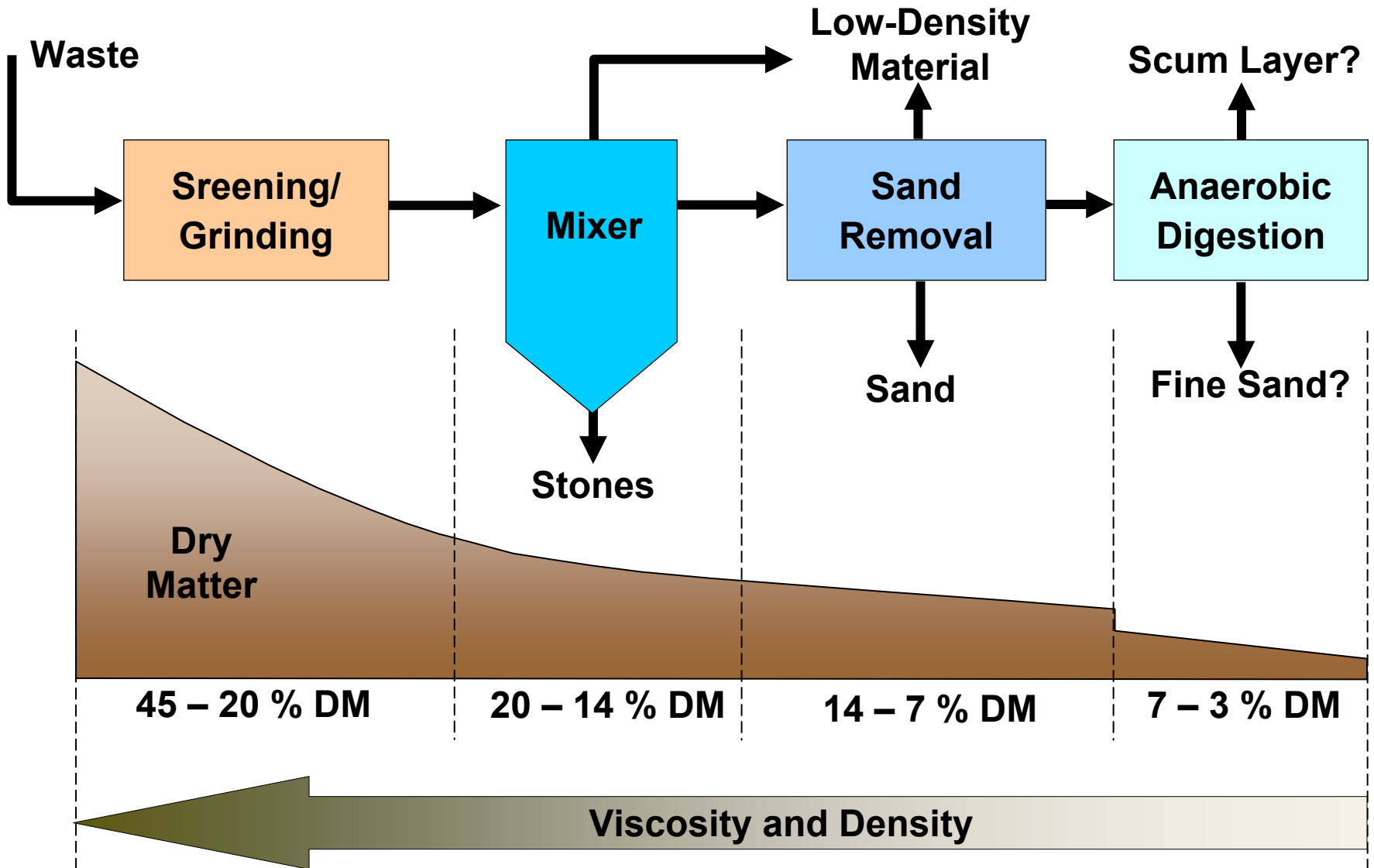

BTA-Process

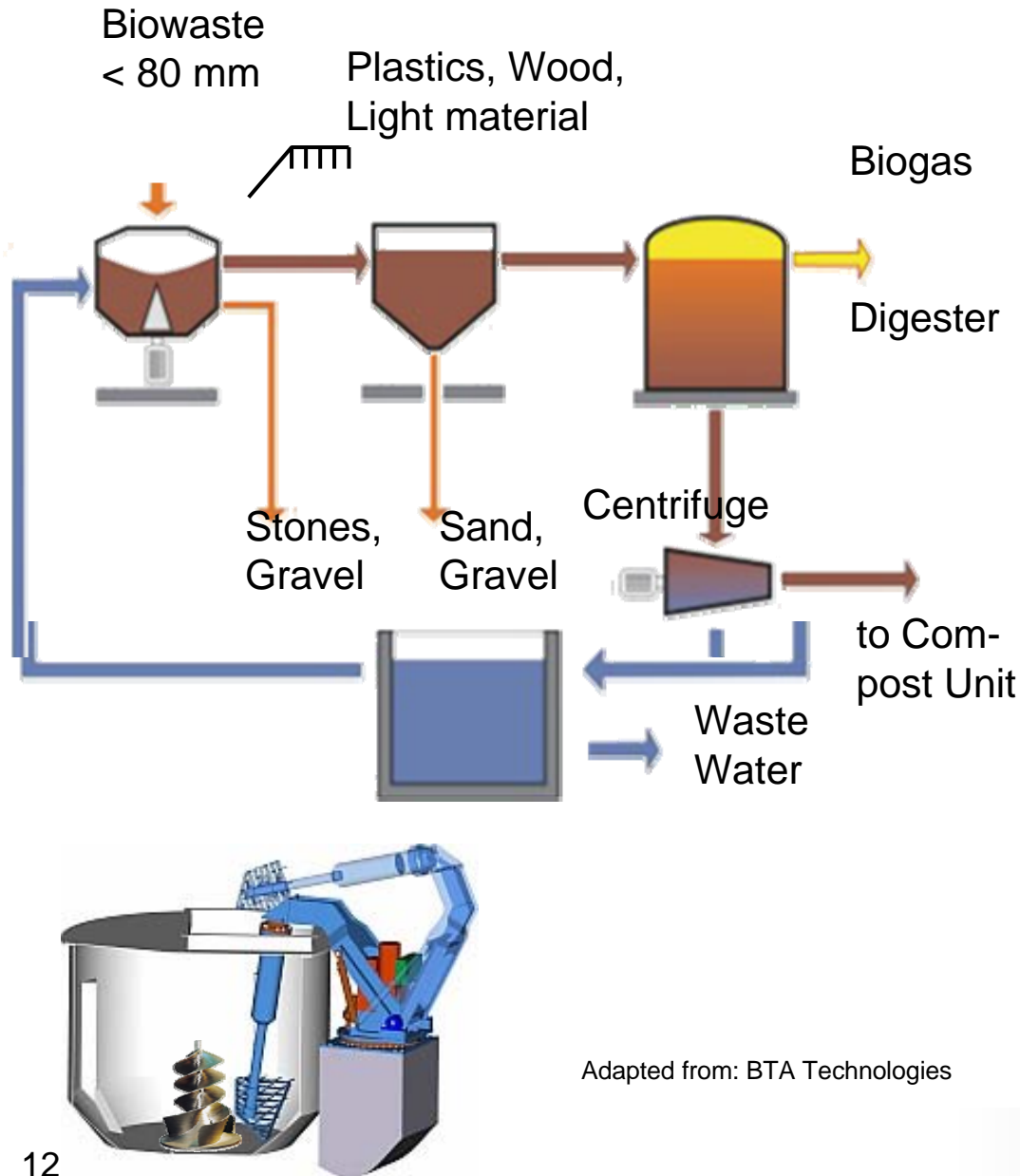

Pulper Technology

Lohse Pulper



Vicentini Pulper
(Ceramic Industry)



PAMA Pulper,
Freiburg



T.C.I.
Turbomixer

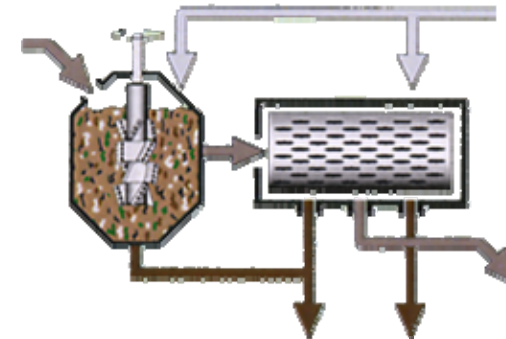

Lohse
„continues“

Concept DBA-WABIO – Wet AD and Wet Contraries Removal

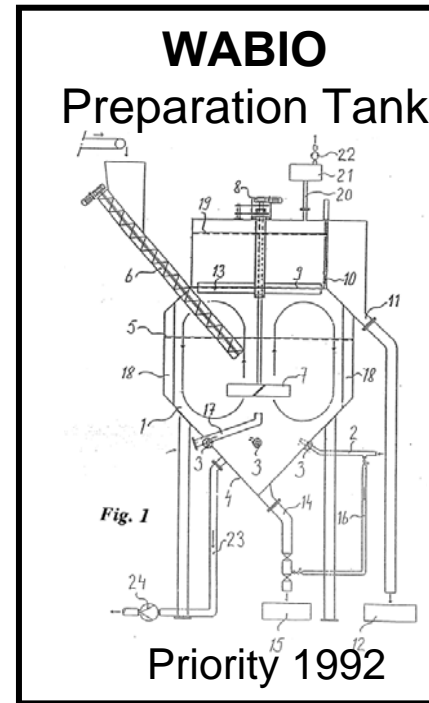
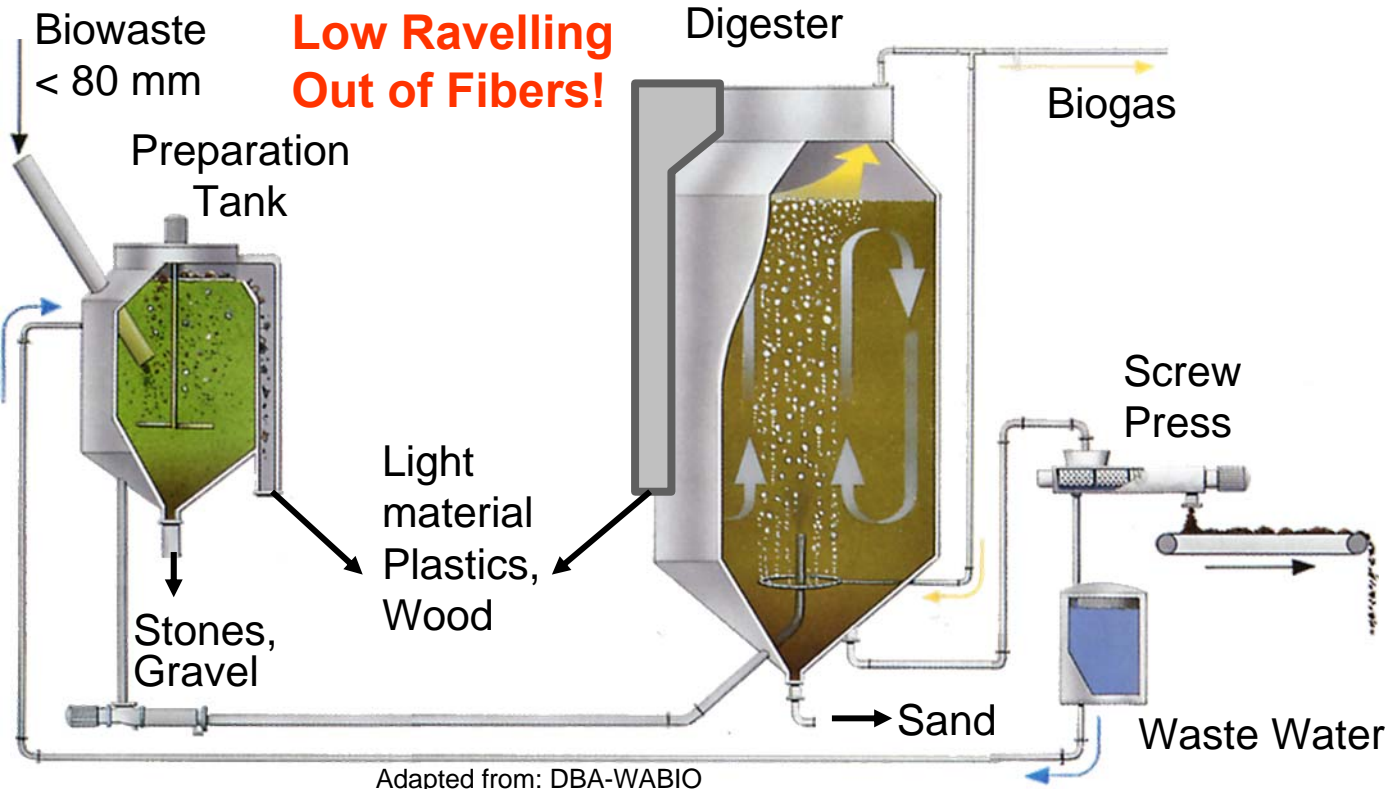

From: Patent Application

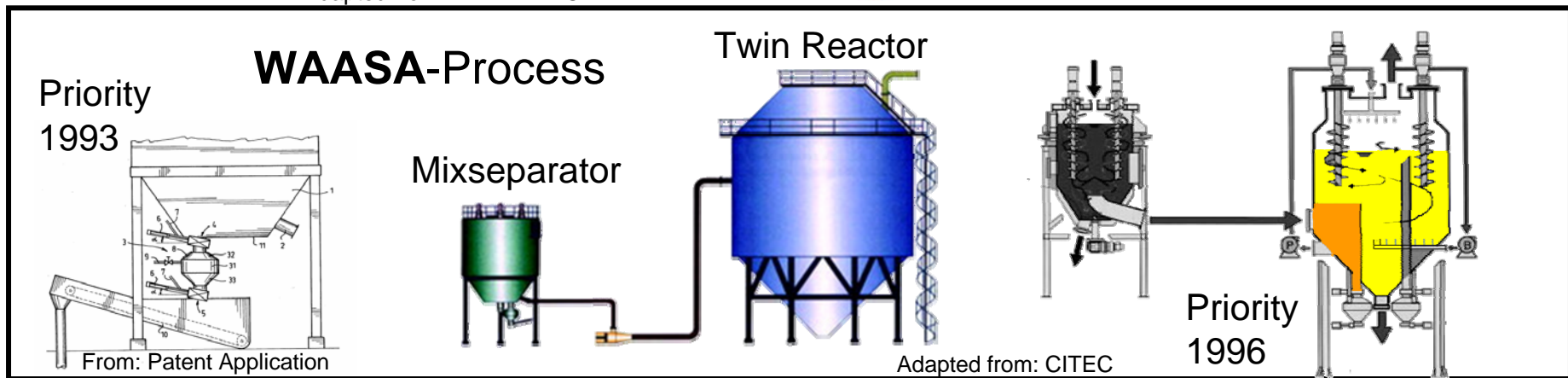

Percolation – Washing / Pressing

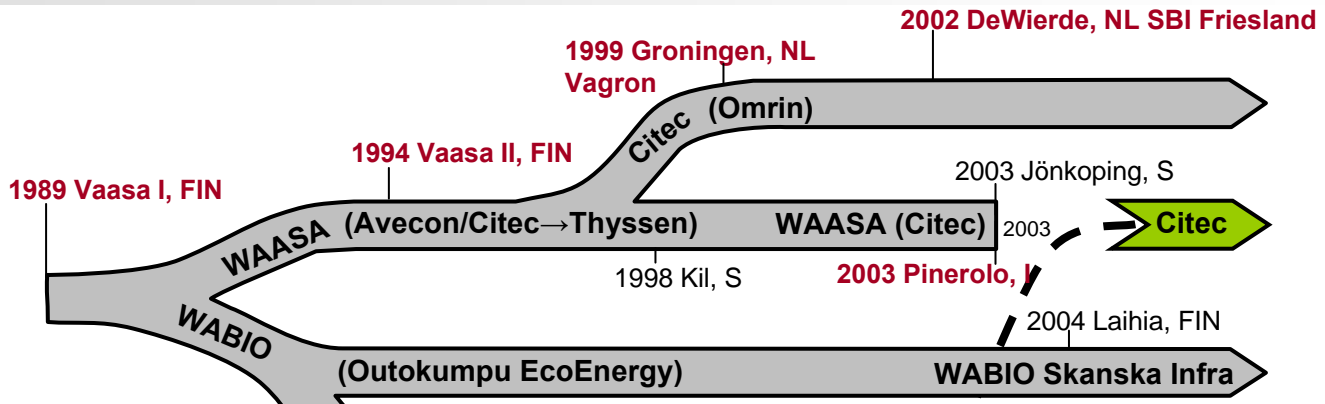

Percolation / Hydrolysis Washing / Pressing

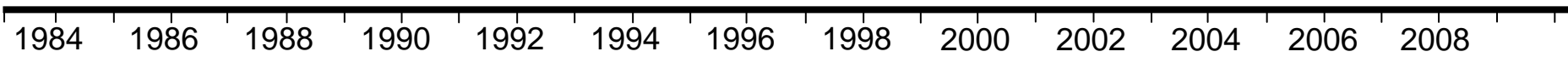
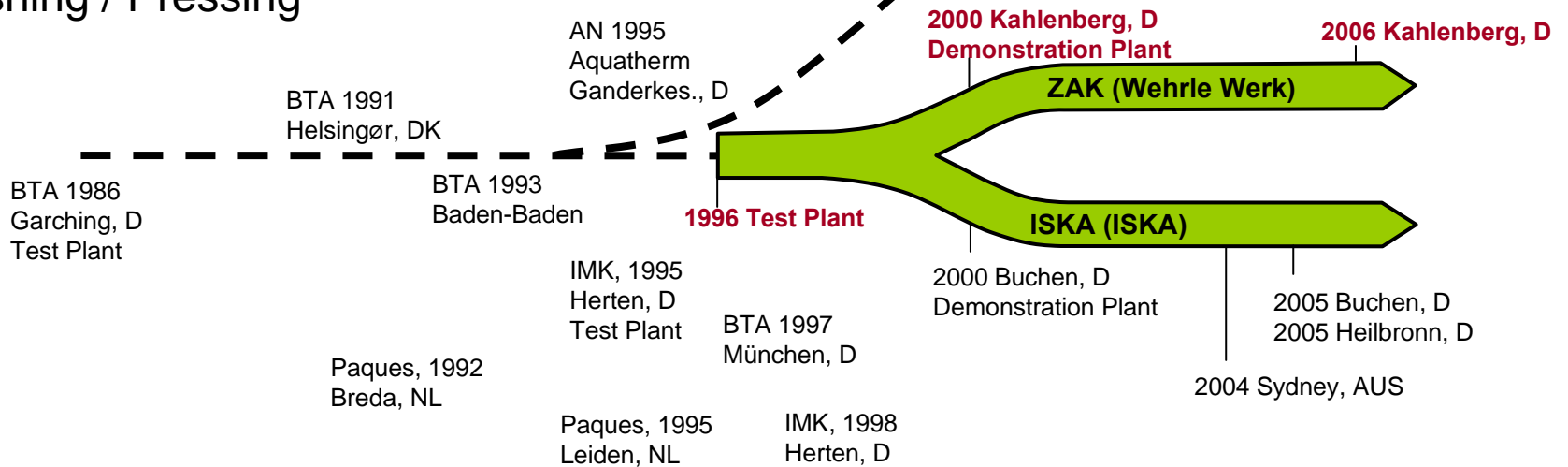

Examples of Washing Processes

Aquatherm, AN Biotec

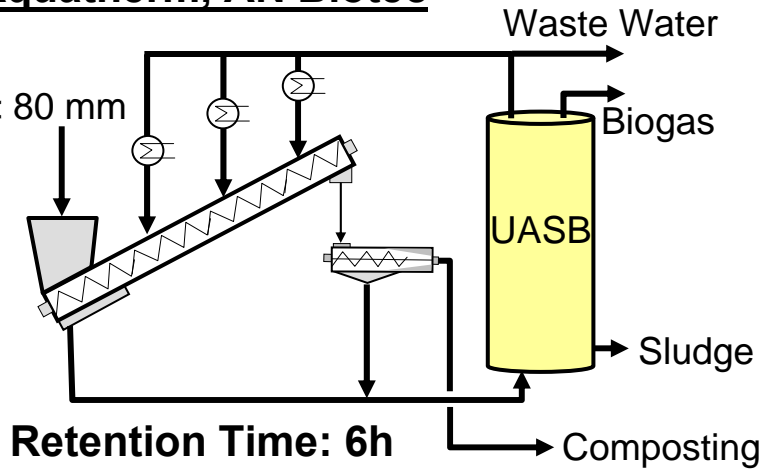

BTA Retention Time: 3d - 4d

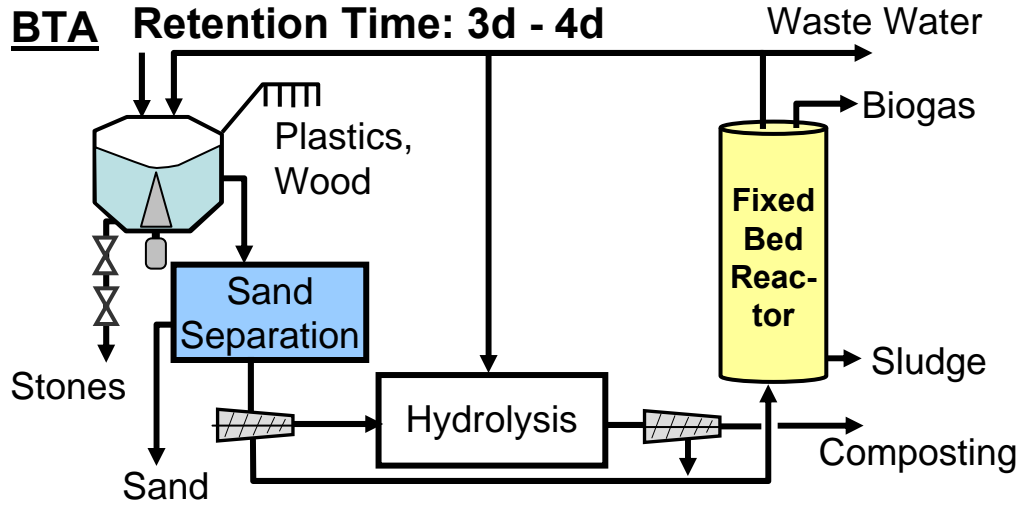

IMK Retention Time: 3d

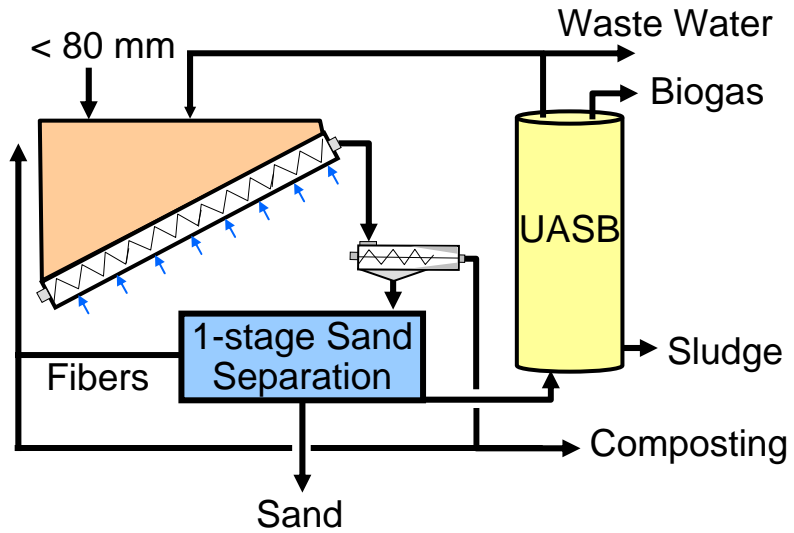

Percolation Retention Time: 2d - 3d

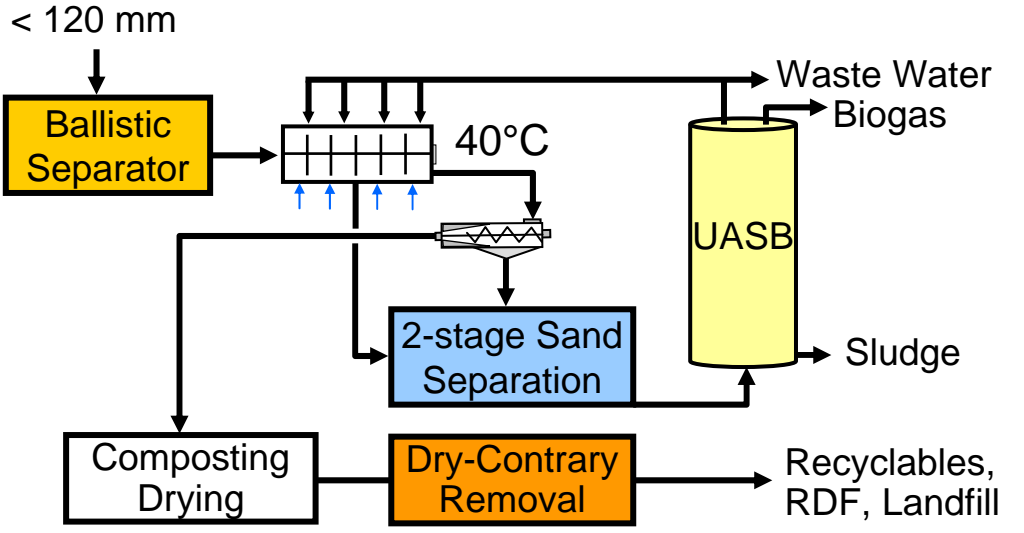

NMT Process - EcoEnergy

